



**GENESIS**

L'INNOVATIVO FRIGO-BAR CON LA PERSONALITÀ DI UN MOBILE CONTENITORE



# Genesis a concept by ISA

ISA è un'azienda italiana, con le radici ben piantate in Umbria. Una storia caratterizzata da costanti innovazioni nella refrigerazione per progetti funzionali e di design in linea con l'evoluzione delle esigenze di moderni locali pubblici. Oggi ISA è una realtà industriale tra i leader mondiali nella refrigerazione professionale e dell'arredamento di locali pubblici.

Genesis nasce dall'incontro tra la tecnologia e la cultura industriale ISA, una realtà industriale che distribuisce in 120 Paesi del mondo soluzioni tecnologiche refrigerate e arredamenti per bar, gelaterie, pasticcerie, ristoranti, gastronomie, laboratori alimentari, supermercati e grande distribuzione.

## EN

ISA is an Italian company with its roots firmly planted in Umbria. A history characterised by constant innovations in refrigeration for functional and design projects in line with the evolving needs of modern public premises. Today ISA is an industrial reality among the world's leader in professional refrigeration and the furnishing of public premises.

Genesis was born from the meeting between ISA's technology and industrial culture. ISA it's a company that distributes refrigerated technology solutions and furnishings for bars, ice cream and pastry shops, restaurants, delicatessens, food processors, supermarkets, and supermarkets in 120 countries around the world.

IT

Genesis, l'innovativo frigo-bar con la personalità di un raffinato mobile contenitore. Realizzato in collaborazione con il designer Sergio Brioschi, questo mobile contenitore è in grado di ambientarsi in tutti i contesti, dalle suite d'hotel alle sale riunioni, dagli uffici presidenziali ai salotti business. Ma anche nel mondo domestico, Genesis, trova una naturale collocazione dall'area notte agli spazi living.

# Genesis

**Contemporaneo, nel segno della sostenibilità.**

EN

**Genesis, Contemporary, in the name of sustainability .**

Genesis, the innovative mini-bar with the personality of a refined storage unit. Realized in collaboration with the designer Sergio Brioschi, this storage unit fits into all contexts, from hotel suites to meeting rooms, from presidential offices to business lounges. But also in the home, Genesis fits in perfectly, from the sleeping area to the living area.





IT

**Il frigo bar pensato da ISA.** Concepito come un mobile contenitore minimale e contemporaneo, il frigo-bar Genesis dispone di due o tre cassetti allineati: uno neutro e uno refrigerato in Genesis 120, uno neutro e due refrigerati in Genesis 180. In entrambe le versioni sono estraibili su guide e dotati di richiamo soft closing.

EN

**The mini-bar designed by ISA.** Conceived as a minimalist and contemporary storage unit, the Genesis mini-bar features two or three aligned drawers: one neutral and one refrigerated in Genesis 120, one neutral and two refrigerated in Genesis 180. These drawers are of the pullout type on runners and are equipped with soft closing.



**Genesis 180**

Exterior: gres porcellanato 12 mm effetto Calacatta Statuario  
Door / Drawers: white glass with silkscreen



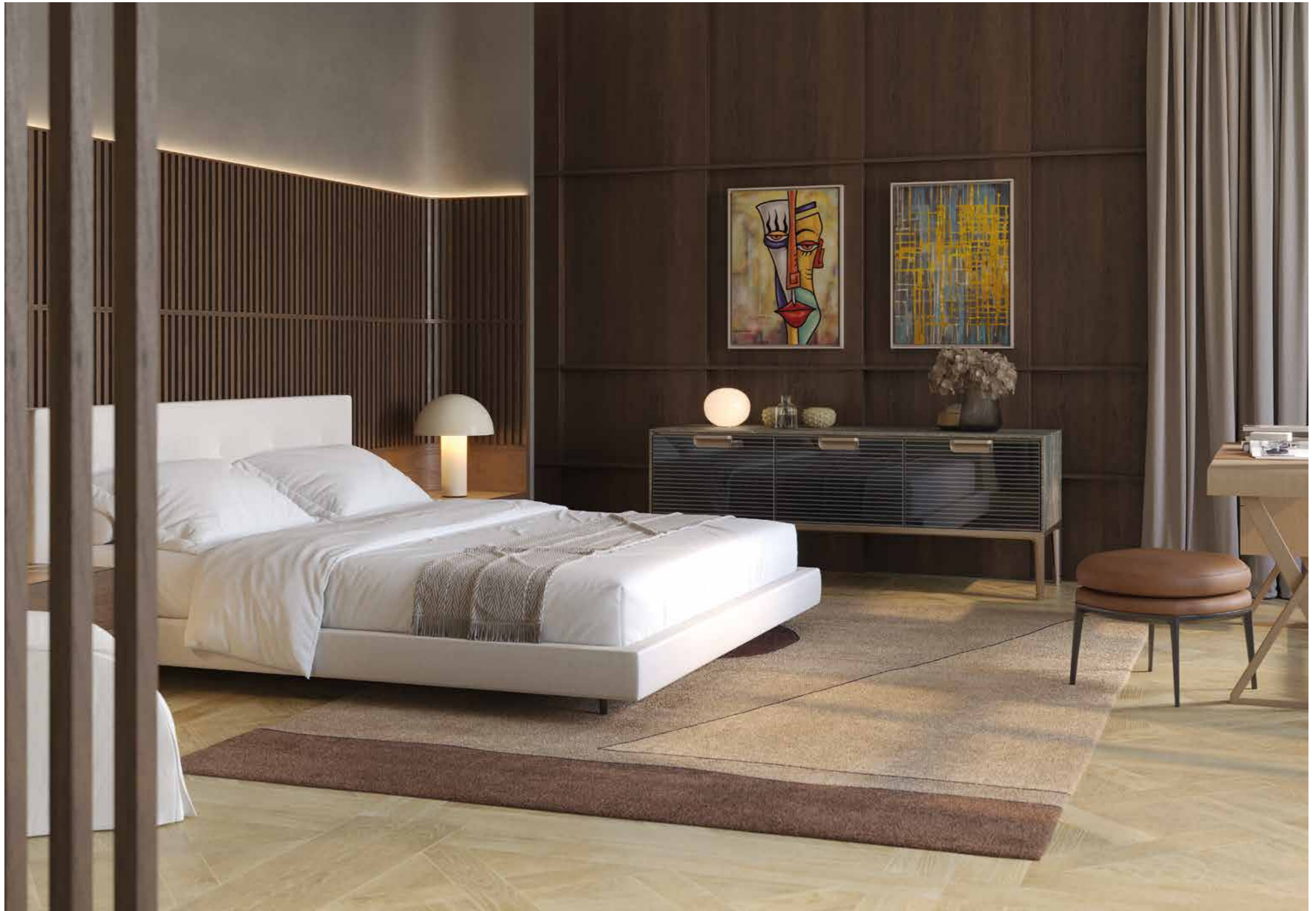

IT

**Personalizzazione.** Il rivestimento esterno è configurabile secondo i diversi codici stilistici per ogni ambientazione in cui verrà collocato. È realizzabile con materiali preziosi e finiture ricercate, dal vetro al marmo, dal legno ai metalli alle ceramiche. L'interno refrigerato, destinato a ospitare vini, soft drink, snack freschi come sandwich e tramezzini, è liberamente configurabile grazie ai divisori regolabili in legno massello e ai ripiani portabottiglie (sia di tipo Bordeaux che Champagnotta).

EN

**Customization.** The outer cladding is configurable according to different stylistic codes for each setting in which it will be placed. It can be realised with precious materials and refined finishes, from glass to marble, from wood to metals to ceramics. The refrigerated interior, designed to accommodate wines, soft drinks, and fresh snacks such as sandwiches and rolls, can be freely configured thanks to the adjustable solid wood dividers and bottle shelves (both Bordeaux and Champagne types).



**Genesis 180**

Exterior: gres porcellanato 12 mm effetto Jatoba  
Door / Drawers: black glass with silkscreen





IT

**Silenziosità e gestione separata della temperatura.**

Le sue peculiarità tecniche - regolazione indipendente della refrigerazione dei cassetti, assoluta silenziosità del motore, sostenibilità del gas refrigerante (R600a) - fanno di Genesis un modello innovativo, destinato ad aprire nuove strade e destinazione d'uso nel settore dei mobili frigo-bar.

EN

**Silent technology and separate temperature control.**

Its technical features - the independent adjustment of the temperature of the drawers, a completely silent motor, the sustainability of the refrigerant gas (R600a) - make Genesis an innovative model, destined to open up new paths and intended uses in the mini-bar furniture sector.

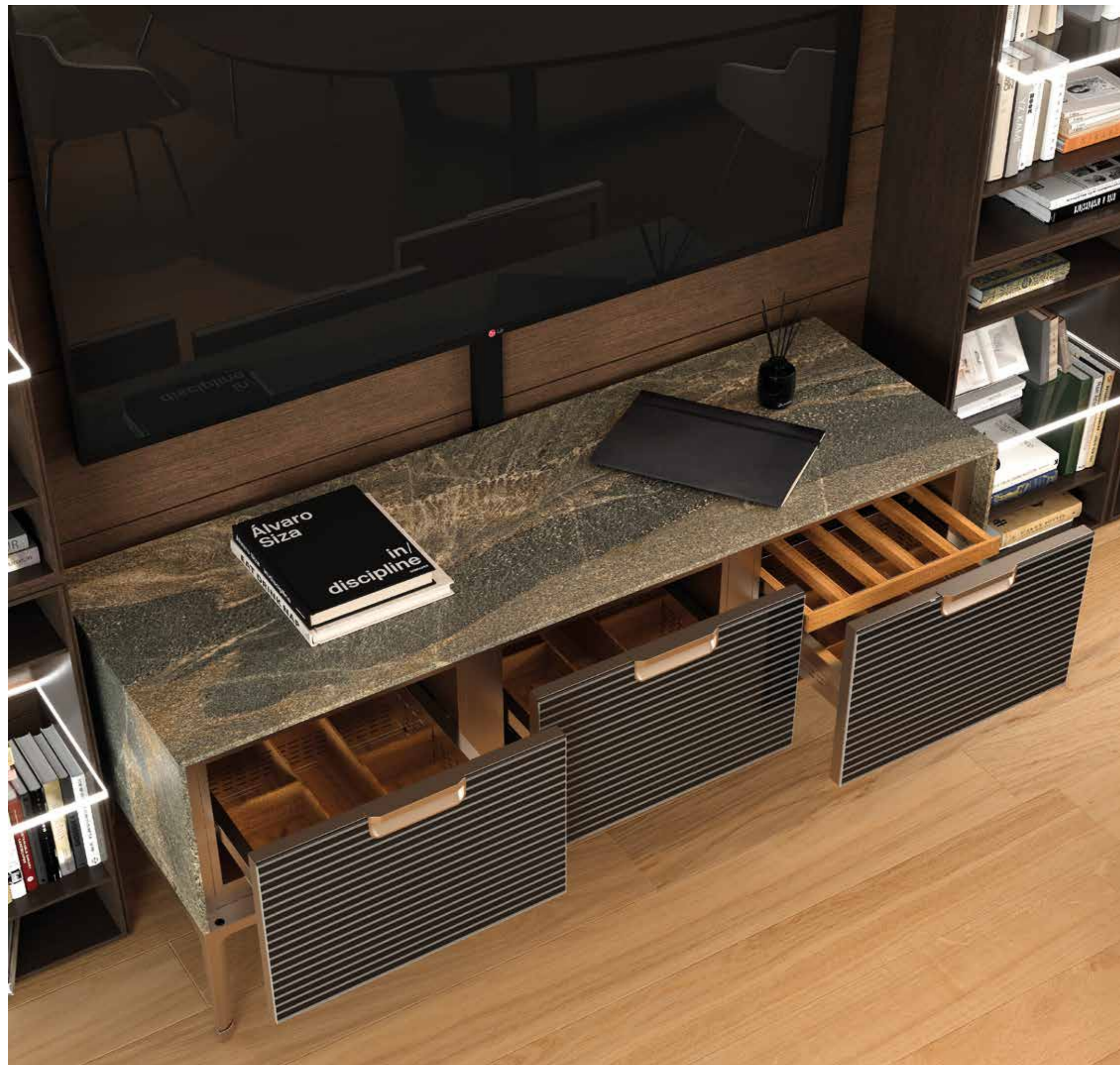

**Genesis 180**

Exterior: gres porcellanato 12 mm effetto Jatoba  
Door / Drawers: black glass with silkscreen

# Genesis

L 120 · 180

D 61

H 71

TN - Chiller



## Struttura

Interno ed esterno del mobile realizzato in acciaio preverniciato nero, o in acciaio inox finitura scotchbrite. Completamente coibentato con schiuma poliuretana espansa a ciclopentano ecologico. Vano neutro sul lato sinistro dotato di cassetto estraibile.

## Installazione

Plug-in

## Temperatura

0 / +18 °C

I due vani refrigerati di Genesis 180 sono a temperatura regolabile indipendentemente.

## Refrigerante

R600a

## Refrigerazione

Statica

## Compressore

Ermetico silenzioso

## Sbrinamento

Fermata compressore

## Classe climatica

N

## Apertura vano refrigerato

Cassetto estraibile su guide

## Apertura vano neutro

Cassetto estraibile su guide

## Basamento

Struttura in pressofusione di alluminio

## Structure

Interior and exterior of cabinet made of black prepainted steel or stainless steel with scotchbrite finish. Fully insulated with polyurethane foam expanded with environmentally friendly cyclopentane. Neutral compartment on left side with pull-out drawer.

## Installation

Plug-in

## Temperature

0 / +18 °C

The two refrigerated compartments of Genesis 180 are independently adjustable.

## Refrigerant

R600a

## Refrigeration

Static

## Compressor

Silent hermetic

## Defrost

Off cycle

## Climate class

N

## Opening system refrigerated compartments

Pull-out drawer on high-slide slides

## Opening system neutral compartments

Pull-out drawer on high-slide slides

## Base structure

Aluminium die-cast structure

L 120

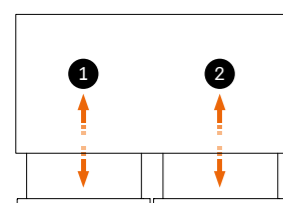

L 180

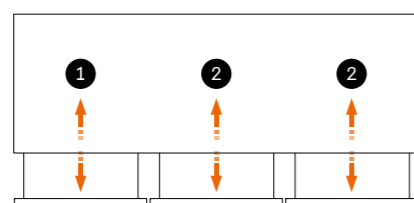

- 1 Vano motore con cassetto neutro  
Compressor compartment with neutral drawer
- 2 Vano refrigerato con cassetti estraibili  
Refrigerated compartment with extractable drawer

## Genesis

	L 120	L 180
Dimensioni esterne (LxPxH) External dimensions (LxDxH)	1218x612x712 mm	1812x612x712 mm
Capacità (lorda/netta) Capacity (gross/net)	76 / 48 Lt	152 / 96 Lt
Peso netto Net weight	105 kg	145 kg
Cassetti Drawer	430x430x120 mm (Nr. 1)	430x430x120 mm (Nr. 2)
Cassetto (Neutro) Drawer (Storage Ambient)	430x250x210 mm (Nr. 1)	430x250x210 mm (Nr. 1)
Refrigerazione Refrigeration	Statica Static	
Refrigerante Refrigerant	R600a	
Classe climatica Climate class	N	
Condizioni ambientali Operating conditions	16°C / 32°C	
Temperatura Temperature	+0°C / +18°C	
Compressore (tipologia) Compressor (type)	Ermetico silenzioso - 1 Silent hermetic - 1	
Sbrinamento Defrost	Fermata compressore Off cycle	
Alimentazione Power supply	230 V / 1 Ph / 50 Hz	
Assorbimento elettrico (a regime) Electrical input (standard)	80 W / 0,5 A	
Assorbimento elettrico (in sbrinamento) Electrical input (defrost)	10 W / 0,1 A	

Dati tecnici riferiti a modelli con unità a bordo con condensazione ad aria / Technical sheet about models with condensing unit included with air cooled

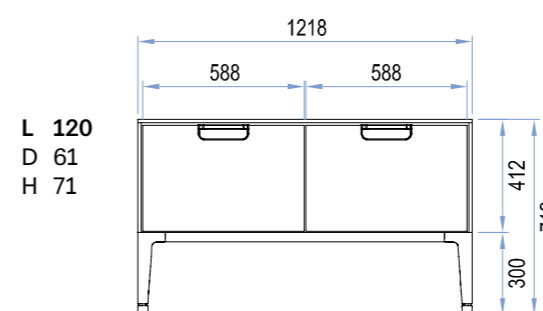

L 120  
D 61  
H 71

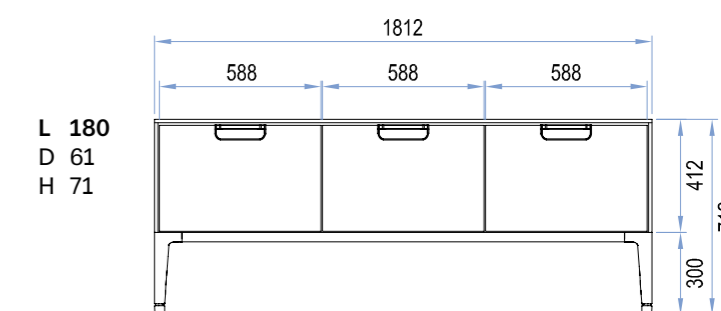

L 180  
D 61  
H 71

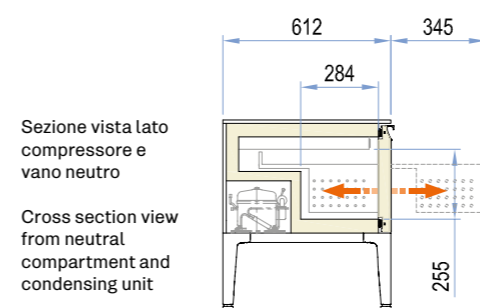

Sezione vista lato compressore e vano neutro

Cross section view from neutral compartment and condensing unit

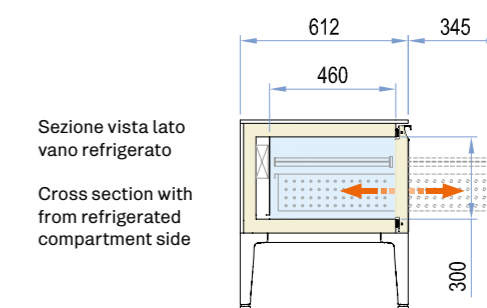

Sezione vista lato vano refrigerato

Cross section with from refrigerated compartment side

# Genesis

## MATERIALI E FINITURE / MATERIALS AND FINISHES

1  
Finiture esterno Gres porcellanato / Porcelain stoneware exterior finishes

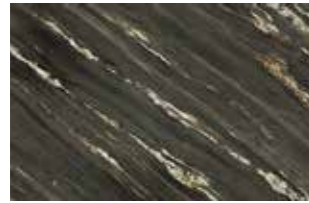

Kuroca



Jatoba Brown



Calacatta Aureo



Calacatta Statuario

1  
Finiture esterno HPL / HPL exterior finishes

Black



K&B #6133 - Marquina

Grey



K&B #2633 - Graphite

White



K&B #6019 - Calacatta

Bronze



K&B #6026 - Desert Road

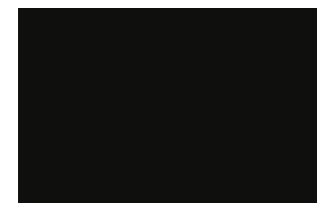

K&B #2423 - Deep Black



K&B #6116 - Nuvolento

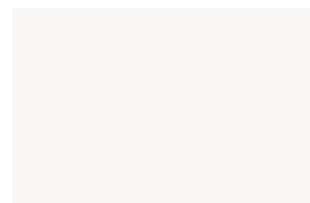

K&B #2409 - Bianco ghiaccio

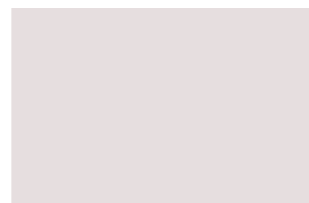

K&B #0164 - Cachemire



K&B #0273 - Samui



Breeze Oak - 1069



K&B #0180 - Monument Oak



Amara Ebony - 1244



Alpi Teak - 1074

2  
Basamento / Base structure

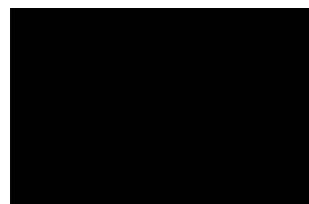

Black  
RAL 9005

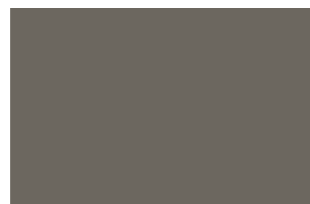

Grigio opaco - Matt grey  
RAL 7039



Elox  
Bronzo

3  
Door - Drawers / Porta - Cassetti

Black



Black glass with silkscreen

Grey

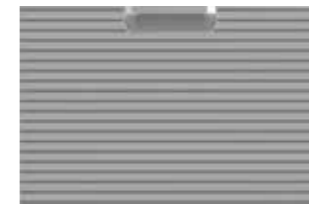

Grey glass with silkscreen

White



White glass with silkscreen

Bronze



Beige glass with silkscreen



K&B #6133 - Marquina



K&B #2633 - Graphite



K&B #6019 - Calacatta



K&B #6026 - Desert Road

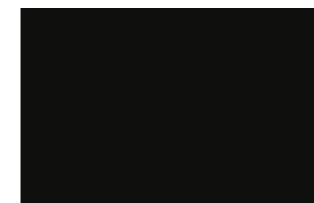

K&B #2423 - Deep Black



K&B #6116 - Nuvolento

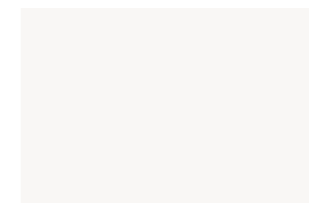

K&B #2409 - Bianco ghiaccio

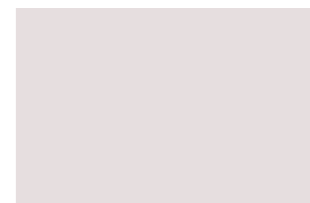

K&B #0164 - Cachemire



K&B #0273 - Samui



Breeze Oak - 1069



K&B #0180 - Monument Oak

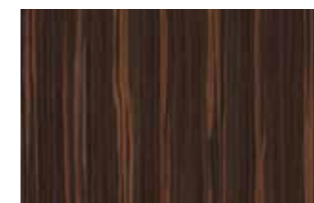

Amara Ebony - 1244



Alpi Teak - 1074

4  
Finiture interne / Inside finishes

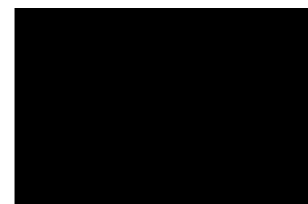

Acciaio verniciato nero  
Black painted steel



Acciaio satinato  
Stainless steel



Rovere tinto  
Stained Oak

5  
Attrezzature interno legno / Internal wood fittings

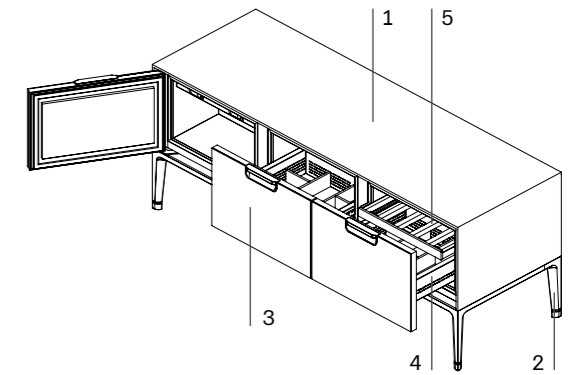

# Genesis

## COLLEZIONI FINITURE / FINISH COLLECTIONS

### BLACK



**Porta / Cassetti  
Door / Drawers**

- Vetro nero con righe  
Black glass with silkscreen
- K&B #6133  
Marquina
- K&B #2423  
Deep Black
- K&B #0273  
Samui
- Amara Ebony  
1244

**Exterior finishes  
Finiture esterno**

- Kuroca
- Jatoba Brown
- K&B #6133  
Marquina
- K&B #2423  
Deep Black
- K&B #0273  
Samui
- Amara Ebony  
1244

**Base structure  
Basamento**

- Black  
RAL 9005
- Acciaio verniciato nero  
Black painted steel

**Attrezzature interno legno  
Internal wood fittings**

- Rovere tinto  
Stained oak

**Inside finishes  
Finiture interne**

### WHITE



**Porta / Cassetti  
Door / Drawers**

- Vetro bianco con righe  
White glass with silkscreen
- K&B #6019  
Calacatta
- K&B #2409  
Bianco ghiaccio

**Exterior finishes  
Finiture esterno**

- Calacatta Aureo
- Calacatta Statuario
- K&B #6019  
Calacatta
- K&B #2409  
Bianco ghiaccio

**Base structure  
Basamento**

- RAL 7039  
Grigio opaco  
Matt grey
- Acciaio satinato  
Stainless steel

**Attrezzature interno legno  
Internal wood fittings**

- Rovere tinto  
Stained oak

**Inside finishes  
Finiture interne**

### GREY



**Porta / Cassetti  
Door / Drawers**

- Vetro grigio con righe  
Grey glass with silkscreen
- K&B #2633  
Graphite
- K&B #6116  
Nuvolento
- Breeze Oak  
1069

**Exterior finishes  
Finiture esterno**

- K&B #2633  
Graphite
- K&B #6116  
Nuvolento
- Breeze Oak  
1069

**Base structure  
Basamento**

- RAL 7039  
Grigio opaco  
Matt grey
- Acciaio satinato  
Stainless steel

**Attrezzature interno legno  
Internal wood fittings**

- Rovere tinto  
Stained oak

**Inside finishes  
Finiture interne**

### BRONZE



**Porta / Cassetti  
Door / Drawers**

- Vetro beige con righe  
Beige glass with silkscreen
- K&B #6026  
Desert Road
- K&B #0164  
Cachemire
- K&B #0180  
Monument Oak
- Alpi Teak  
1074

**Exterior finishes  
Finiture esterno**

- K&B #6026  
Desert Road
- K&B #0164  
Cachemire
- K&B #0180  
Monument Oak
- Alpi Teak  
1074

**Base structure  
Basamento**

- Elox  
Bronzo
- Acciaio satinato  
Stainless steel

**Attrezzature interno legno  
Internal wood fittings**

- Rovere tinto  
Stained oak

**Inside finishes  
Finiture interne**

# Contemporaneo, nel segno della sostenibilità.

## IT

Genesis è un progetto di refrigerazione silenzioso e tecnologicamente ad alto valore aggiunto in termini di sostenibilità. Per ridurre l'impatto delle emissioni nell'ambiente, anticipando le linee guida in materia della commissione europea, ISA utilizza solo gas naturale per la refrigerazione: l'R290, l'R744 e l'R600a sono best performer secondo il rating del Global Warming Potential Index.

## EN

**Contemporary style in the name of sustainability.** Genesis is a silent and technologically advanced refrigeration project of the highest value in terms of sustainability. In order to reduce the impact of emissions on the environment, anticipating the European Commission's guidelines on the subject, ISA uses only natural gas for refrigeration: R290, R744 and R600a are best performers according to the Global Warming Potential Index rating.

## Genesis

### FEATURES

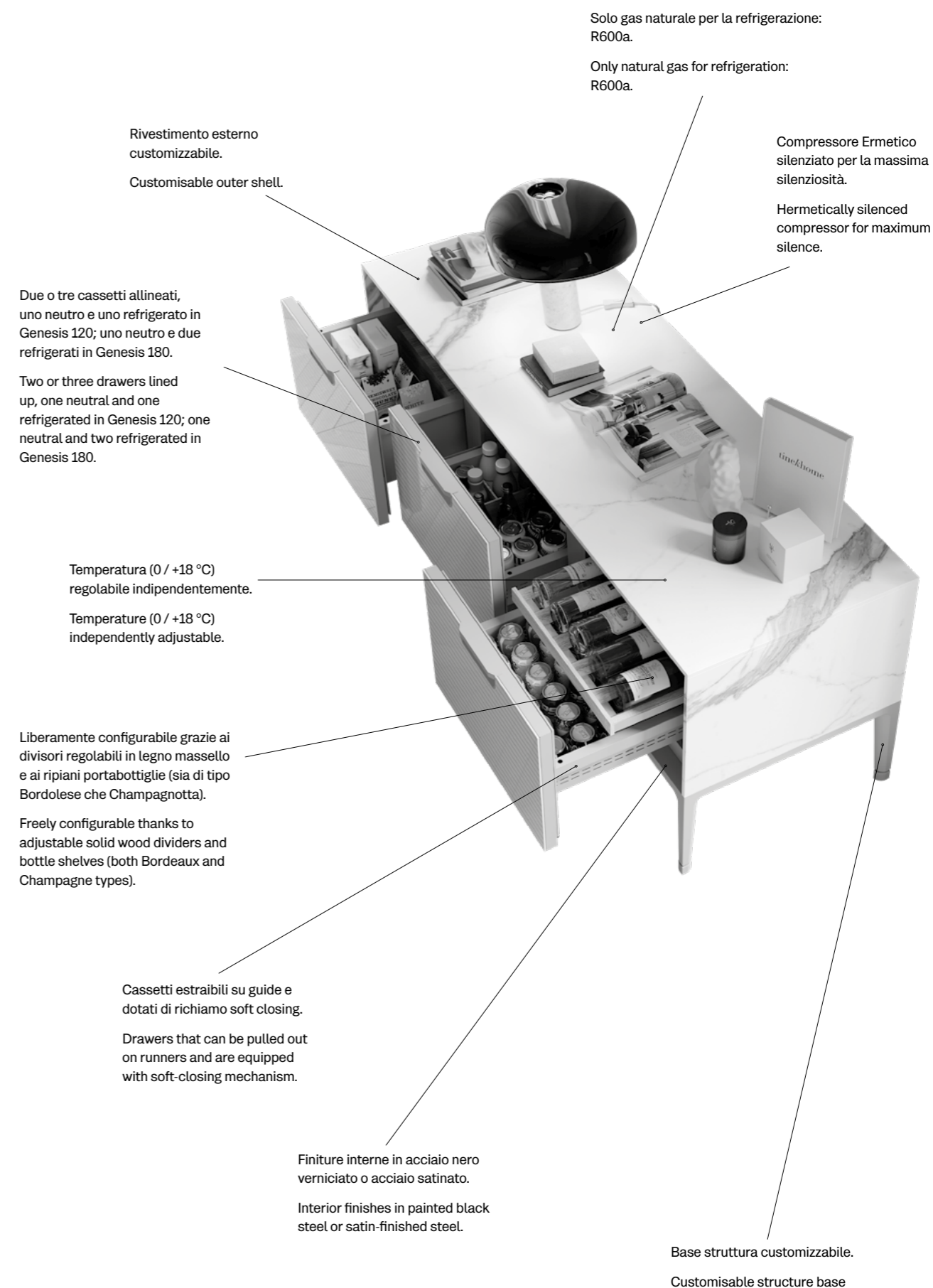

Solo gas naturale per la refrigerazione:  
R600a.

Only natural gas for refrigeration:  
R600a.

Compressore Ermetico  
silenziato per la massima  
silenziosità.

Hermetically silenced  
compressor for maximum  
silence.

Rivestimento esterno  
customizzabile.

Customisable outer shell.

Due o tre cassetti allineati,  
uno neutro e uno refrigerato in  
Genesis 120; uno neutro e due  
refrigerati in Genesis 180.

Two or three drawers lined  
up, one neutral and one  
refrigerated in Genesis 120; one  
neutral and two refrigerated in  
Genesis 180.

Temperatura (0 / +18 °C)  
regolabile indipendentemente.

Temperature (0 / +18 °C)  
independently adjustable.

Liberamente configurabile grazie ai  
divisori regolabili in legno massello  
e ai ripiani portabottiglie (sia di tipo  
Bordolese che Champagnotta).

Freely configurable thanks to  
adjustable solid wood dividers and  
bottle shelves (both Bordeaux and  
Champagne types).

Cassetti estraibili su guide e  
dotati di richiamo soft closing.

Drawers that can be pulled out  
on runners and are equipped  
with soft-closing mechanism.

Finiture interne in acciaio nero  
verniciato o acciaio satinato.

Interior finishes in painted black  
steel or satin-finished steel.

Base struttura customizzabile.

Customisable structure base



Dealer partner

**rossidialbizzate**

Showroom: Milano  
Via Francesco Sforza, 4

T. +39 02 38319358,  
store@rossidialbizzate.it  
export@rossidialbizzate.it





**ISA S.p.A.**

via Madonna di Campagna 123  
06083 Bastia Umbra (PG) Italy  
T. +39 075 801 71

**isaitaly.com**

Dealer partner  
**Rossi di Albizzate**

Showroom: Milano  
Via Francesco Sforza, 4

T. +39 02 38319358,  
store@rossidialbizzate.it  
export@rossidialbizzate.it